



QUICK START GUIDE

ELECTROMAGNETIC COMPATIBILITY

ALL MODELS

INTRODUCTION

Trio Motion Technology products are certified to comply with the requirements of Annex I to the Directive 2014/30/EU on Electromagnetic disturbance and Electromagnetic immunity. To achieve this compliance, certain requirements or best engineering practices must be implemented by the corresponding system designer.

INTENDED CONDITIONS OF USE

Trio Motion Technology products are designed for operation in Industrial environments with high noise levels that may induce currents or electrical potentials that are damaging to microelectronics. Our products are nevertheless designed and tested to withstand the level of electromagnetic disturbance common to these environments, on the provision that the appropriate EMC guidelines have been employed by a qualified competent system integrator.

The Trio Motion Technology product range is designed to be integrated, by the customer, as a control system for industrial machines and auxiliary equipment.

PRODUCT SPECIFIC REQUIREMENTS

Trio Motion's extensive product and application knowledge combined with product testing reflect that the best immunity is achieved by placing some constraint on the system into which the product is being integrated. This information is recorded in the Product Technical Manual (available at www.triomotion.com) and presented in this document for the commissioning engineer.

Product	Specific Feature	Requirements
ALL	0V wire (current return)	<ol style="list-style-type: none"> 1. Always connect ALL 0V current return wires 2. Do not use the screen for 0V current return 3. It is highly recommended to avoid connecting 0V across internal isolation barriers. If a single 24V supply is used for the main power and IO power then these two isolated 0V will have to be connected but this should only be done if the 24V supply is free from switching noise 4. Do not join together 0V from high power and / or noisy sources with the 0V from signal ports (incl. CAN bus DC input) 5. Do not use any controller 0V connection as a current return for peripheral devices
ALL	All 24V DC ports	<ol style="list-style-type: none"> 1. It is highly recommended to use surge filters on all DC supply and 0V return. If more than one device is connected to the same PSU then this is a requirement, (see Surge Protection on page 6 and Product Technical Manual)
ALL	Cable routing	<ol style="list-style-type: none"> 1. Maintain 150mm separation of parallel Class I and Class II cable (IEC 61000-5-2:1997) (see manual) 2. Unless otherwise specified, all cables must be <30m in length
ALL	Proximity to source of disturbance	<ol style="list-style-type: none"> 1. Place controllers and expansion modules as far from mains cables, mains filters, contactors, circuit breakers, drives, transducers or other high power sources of EM disturbance as physically possible within the enclosure design
ALL	Enclosure / Safety Cabinet design	<ol style="list-style-type: none"> 1. Trio's products should always be installed within a locked cabinet with access limited to authorised personnel only

Product	Specific Feature	Requirements
ALL	Differential Stepper / Encoder Signals	<ol style="list-style-type: none"> 1. Screened, twisted pair cable 2. Connect screen to metal chassis at both ends (See Cable Shields on page 11 and Product Technical Manual) 3. 0V reference connected at both ends
ALL	CAN bus	<ol style="list-style-type: none"> 1. Screened, twisted pair cable with characteristic impedance of 120 Ohm (± 10 Ohm) 2. Connect screen to Chassis at every node
ALL	Digital I/O	<ol style="list-style-type: none"> 1. It is highly recommended to separate PSU and 0V return (the I/O is internally isolated)
ALL	ADC / DAC	<ol style="list-style-type: none"> 1. Use DAC 0V reference pin not common 0V
ALL	RS232 / RS422 / RS485 Serial ports	<ol style="list-style-type: none"> 1. Screened cable 2. Connect screen to Chassis at both ends 3. 0V reference connected at both ends 4. (See cable shields, page 11 and in Product Technical Manual)
ALL	Ethernet	<ol style="list-style-type: none"> 1. Overall Foil Braided Shield / Unshielded Twisted Pair, (Compliant with Industrial SF/UTP and TIA Cat5e, minimum) 2. Cable ≤ 30m in length
ALL	EtherCAT	<ol style="list-style-type: none"> 1. Overall Foil Braided Shield / Unshielded Twisted Pair, (Compliant with Industrial SF/UTP and TIA Cat5e, minimum) 2. Connect screen to Chassis at both ends, this is achieved by the shield connection built in to the RJ45 socket 3. Cable ≤ 30m in length

Product	Specific Feature	Requirements
Controllers with metal chassis or metal back panel	Protective Earth Connection	<ol style="list-style-type: none"> 1. Mount on bare metal backplane 2. Use a minimum 4mm wide but preferred 10mm wide, braided conductor to connect Chassis to PE, as close to the <i>Motion Coordinator</i> as possible 3. (See EMC Earth on page 9 and EMC Section in the Product Technical Manual)
Flexslice Coupler Flex-6 Nano	Cable routing	<ol style="list-style-type: none"> 1. Cable <100m in length
HMI Uniplay	Chassis Ground	<ol style="list-style-type: none"> 1. Connect between FG on the HMI power terminal and machine chassis or local PE 2. At a minimum: #14 AWG Ground wire 3. Highly recommended: 10mm wide braided conductor to connect FG to machine chassis or PE, as close to the HMI as possible
MC4N	SD Card Slot	<ol style="list-style-type: none"> 1. Retain plastic slot protector when not in use
MC302X	All Cables	<ol style="list-style-type: none"> 1. Screened cable 2. Connect screen to Chassis at both ends (See Cable Shields on page 11 and Product Technical Manual) 3. 0V reference connected at both ends
MC4XX / MC5XX / MC6XX	Digital I/O	<ol style="list-style-type: none"> 1. Screened cable or EMC Mesh, (due to high speed inputs) 2. Connect screen to metal chassis at both ends
MC464	RS232 / RS485	<ol style="list-style-type: none"> 1. <3m in length
PC-MCAT	All Cables	<ol style="list-style-type: none"> 1. <3m in length except for Ethernet and Ethercat ports

RECOMMENDED INSTALLATION

The following diagrams and information detail the typically required Surge Protection, EMC Earth and Cable Shields however more comprehensive information can be found in the corresponding Product Technical Manual (available at www.triomotion.com)

SURGE PROTECTION

SINGLE POWER SUPPLY

Where the device is supplied with 24V dc from one dedicated 24V power source and the connecting cable is less than 3 metres, there is no need for a separate surge protection device.

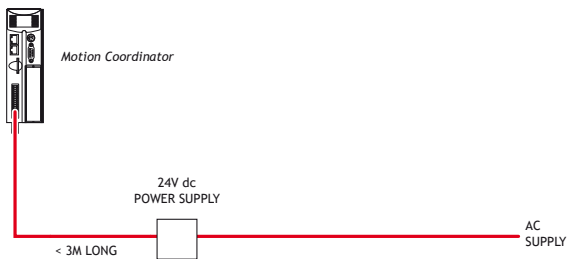

Motion Coordinator with dedicated power source

DISTRIBUTED POWER SUPPLY

If the device is connected to a distributed power supply or the cable length between the power source and the device is longer than 3 metres, then a surge protection device must be fitted to comply with the CE EMC directive.

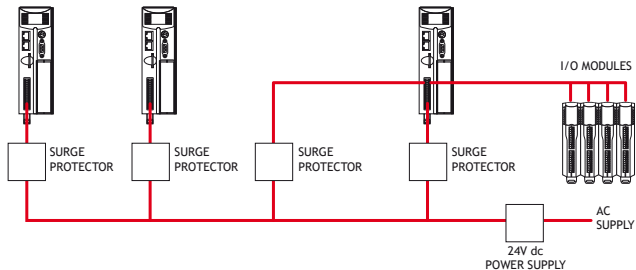

Distributed power supply with surge protection

MC664 / MC464 AND IO DEVICES

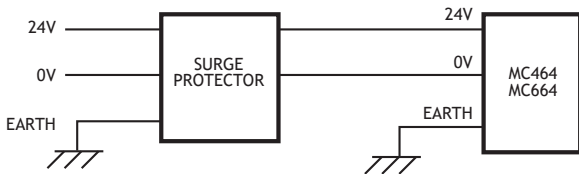

Surge protection device

MC403 / MC405

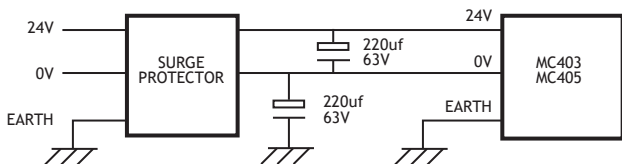

Surge protection device



If the I/O power is from a different power source to the main device power, then the I/O power must also have a surge protector fitted.

EMC EARTH

Typical additional earth attachment.

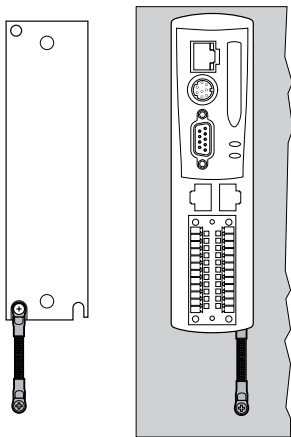

MC4N Earth Braid shown rear (left) and front (right)

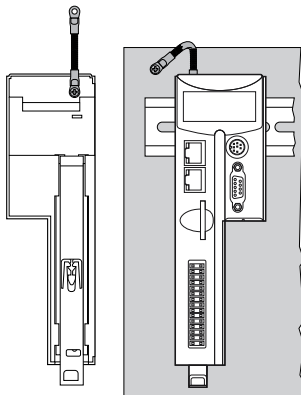

MC664 / MC464 Earth Braid shown rear (left) and front (right)

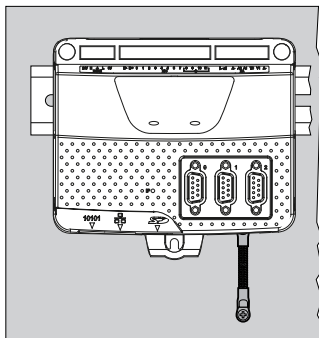
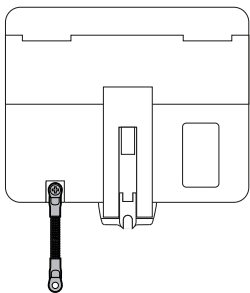

MC403 Earth Braid. MC508 / MC405 is Similar

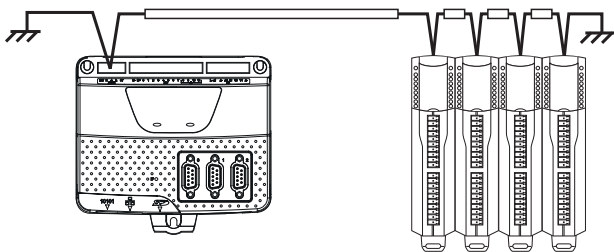

MC403 and CAN I/O Modules

CABLE SHIELDS

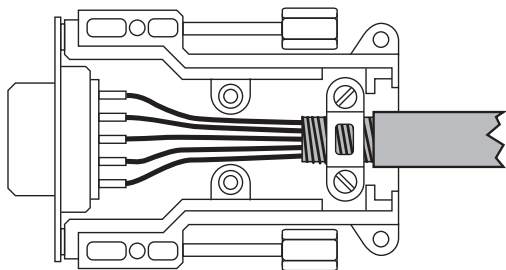

Both ends of the encoder cable's screen must be connected using a 360 degree contact and not a pig-tail connection.

The 0V must be connected separately from the screen. Make sure that encoder cables are specified with one extra wire to carry the 0V.

SCREEN CONNECTED INTERNALLY
TO METAL SHIELD



SCREEN CLAMPED
TO EARTH

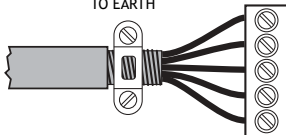

All serial cables must be terminated in an 8-pin mini-DIN connector. For best EMC performance, clamp the screen of the serial cable where it enters the connector cover. Do not make a "pig-tail" connection from the screen to the plug cover.



Both ends of the serial cable's screen must be connected using a 360 degree contact and not a pig-tail connection.

The 0V must be connected separately from the screen. Make sure that serial cables are specified with one extra wire to carry the 0V.

This applies to RS422/RS485 serial connections as well as RS232.

UK | USA | CHINA | INDIA
WWW.TRIOMOTION.COM
THE MOTION SPECIALIST

CAD data Drawings to aid packaging and mounting are available in various formats from the Trio web site. Products should be wired by qualified persons.
Specifications may change without notice. E & OE

Quick Start v4.0 February 2019